



STEPS & TIPS FOR PUTTING UP AND USING YOUR DISPLAY

YOUR DISPLAY SHOULD COME WITH THE FOLLOWING:

1 BOX INCLUDING THE FOLLOWING

3 GRID PANELS,

1 TRIANGULAR BASE

HOOKS

PLASTIC BAG WITH WHEELS

PLASTIC BAG WITH CLIPS, BOLTS, SCREWS AND TOOLS FOR ASSEMBLY

3 BOXES OF SAMPLE CARDS LABELED FOR EACH SIDE OF DISPLAY

STEP 1

ASSEMBLE TRIANGULAR GRID DISPLAY USING THE ASSEMBLY INSTRUCTIONS

STEP 2

BY USING THE PLANOGRAM FOUND IN THIS DOCUMENT, PUT THE HOOKS ONTO THE DISPLAY IN THE MARKED SPOTS ON THE GRID

TIP IT WILL BE EASIEST TO DO ONE SIDE OF THE DISPLAY AT A TIME
NOT EACH SIDE OF THE DISPLAY HAS THE SAME HOOK LAYOUT
YOUR PLANOGRAM WILL POINT OUT WHERE THE HOOKS GO WITH 

STEP 3

ONCE THE HOOKS ARE IN PLACE FIND THE COORDINATING SAMPLE CARD BOX (COOL, WARM, NEUTRAL) AND UNPACK BUNDLED SAMPLE CARDS

TIP SAMPLE CARDS ARE BUNDLED BY HOOK # - ORGANIZE THEM NUMERICLLY FOR FASTEST SET UP

STEP 4

AS YOU UNPACK YOUR SAMPLE CARDS PUT THEM ON THE COORDINATING HOOK #

STEP 5

REPEAT STEPS 2-4 FOR THE 2 REMAINING DISPLAY SIDES AND SHOP BY COLOR!

IMPORTANT!

MANISCALCO WILL REPLACE MISSING DISPLAY CARDS FOR FREE. PLEASE USE THE REPLENISHMENT FORM INCLUDED WITH THIS DOCUMENT TO REORDER WHEN YOU INVENTORY YOUR DISPLAY. WE WILL NOTIFY YOU WHEN CARDS NEED TO BE REMOVED AND WHEN NEW CARDS ARE COMING.

SHOP BY COLOR PLANOGRAM - HOOK PLACEMENT

17 HOOKS NEEDED FOR COOL SIDE



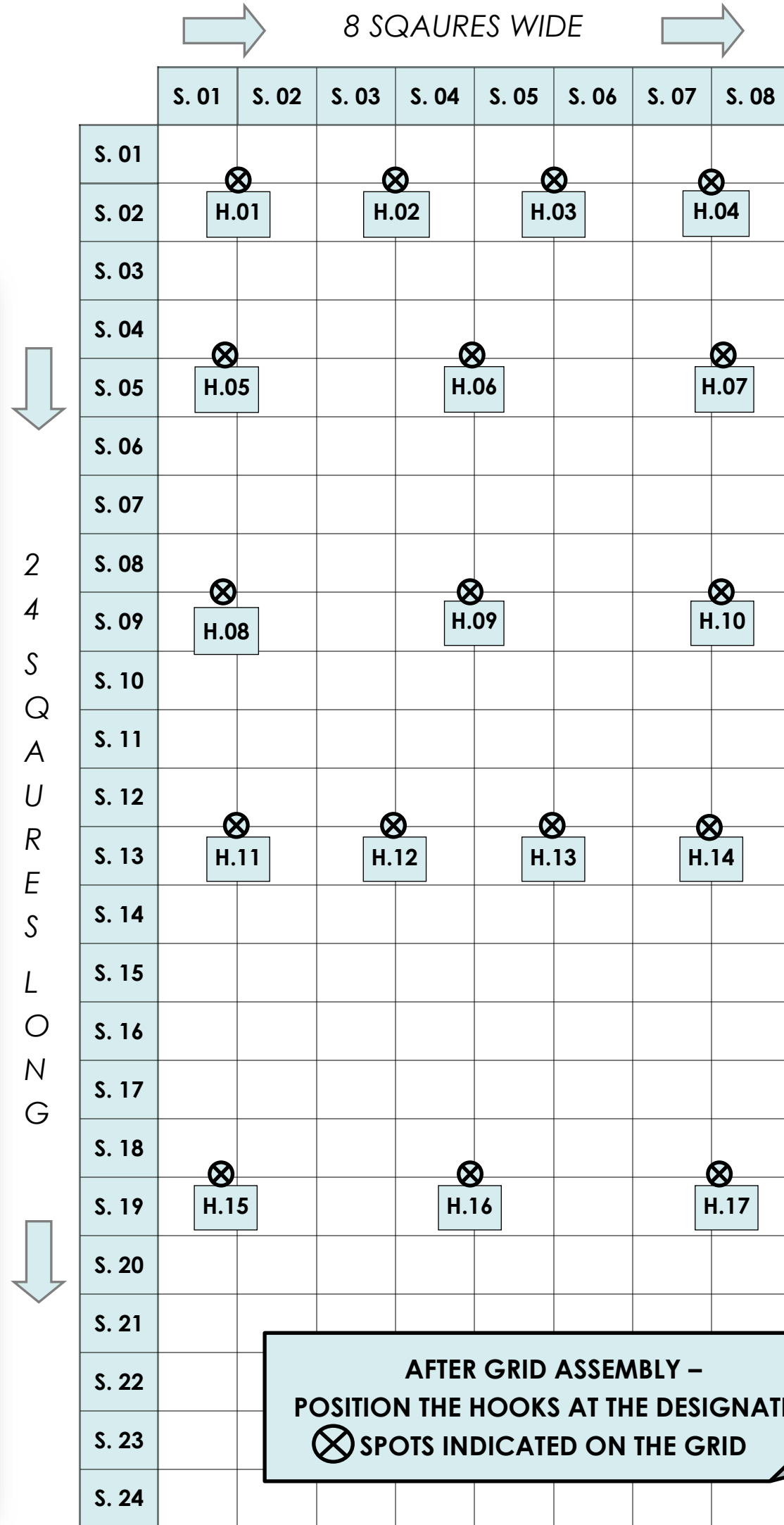





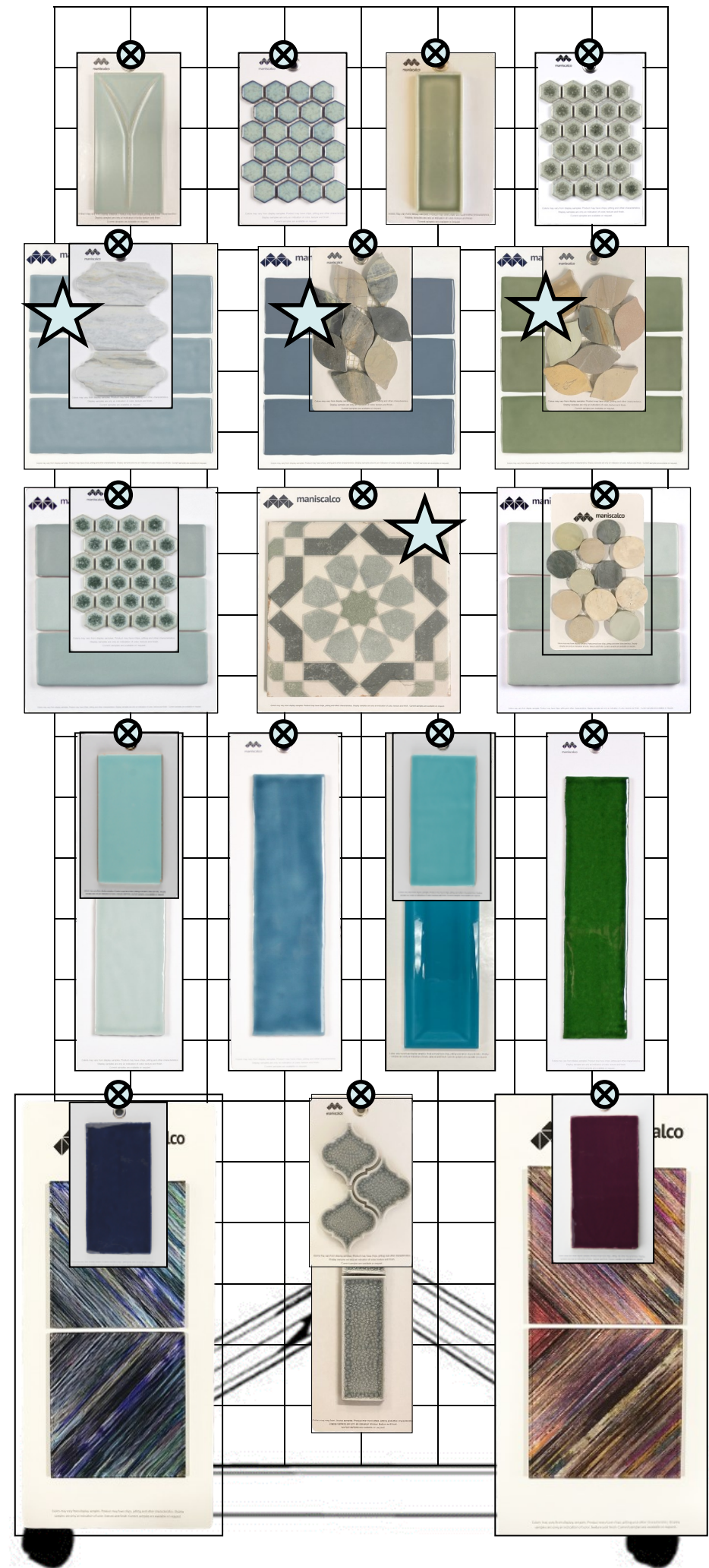



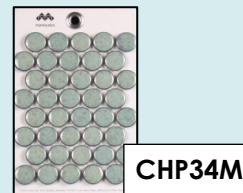

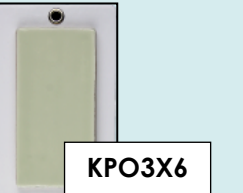





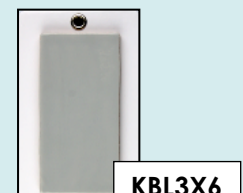











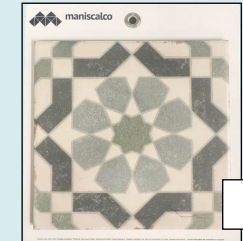





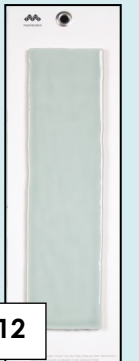
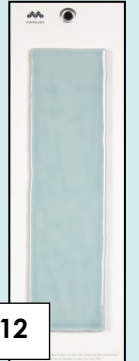
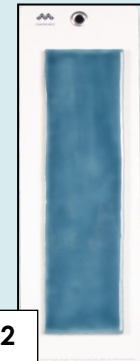
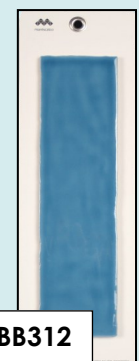
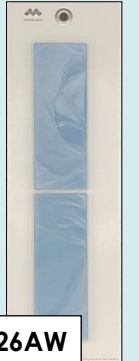
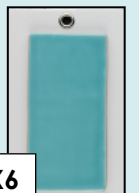

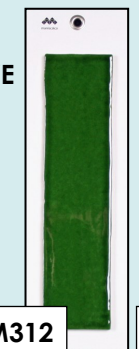
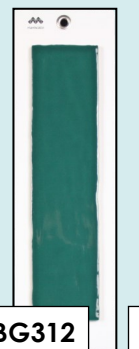
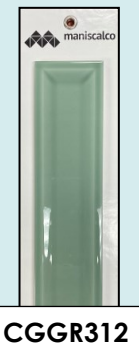
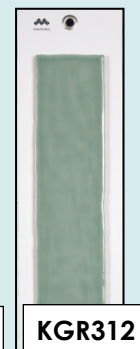

PRO TIP:
LAYOUT THE HOOKS BEFORE YOU LOAD CARDS

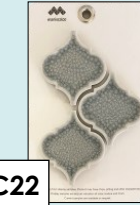

**AFTER GRID ASSEMBLY –
POSITION THE HOOKS AT THE DESIGNATED
⊗ SPOTS INDICATED ON THE GRID**

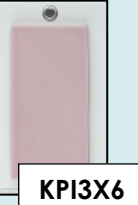
NEW CARDS!!

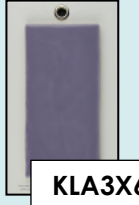

<p>H01. HOOK 1 TABB3X6/BLUE BEECH/MSC5X8114 Q207/SEA GREEN/MSC5X8028</p>   <p>TABB3X6 Q207</p>	<p>H02. HOOK 2 CHH11MR/MINT ROSE HEX/MSC5X8136 CHP34MR/MINT ROSE PENNY/MSC5X8137</p>   <p>CHH11MR CHP34MR</p>	<p>H03. HOOK 3 ME26UM/URBAN MEADOW/MSC5X8121 KPO3X6/PISTACHIO/MSC5X8079 KGB3X6/GREEN BRANCH/MSC5X8067</p>    <p>ME26UM KPO3X6 KGB3X6</p>	<p>H04. HOOK 4 CHH11SG/SAGE GREEN HEX/MSC5X8131 CHP34SG/SAGE GREEN PENNY/MSC5X8135 KGT3X6/GREEN TURTLE/MSC5X8068</p>    <p>CHH11SG CHP34SG KGT3X6</p>
<p>H05. HOOK 5 P24VAZ/VALLEE AZUR/MSC5X8141 KLB3X6/LIGHT BLUE/MSC5X8073 KCM2X8/COASTAL MIST/MSC910023</p>    <p>P24VAZ KLB3X6 KCM2X8</p>	<p>H06. HOOK 6 Q618/BLUE ATLAS/MSC5X8146 KSC2X8/SERENE COVE/MSC910024</p>   <p>Q618 KSC2X8</p>	<p>H07. HOOK 7 Q603/OLIVE LEAVES/MSC5X8145 Q503/OLIVE COIN/MSC5X8033 Q203/OLIVE SLICED/MSC5X8025</p>      <p>Q603 Q503 Q203 KOG3X6 KOG2X8</p>	
<p>H08. HOOK 8 CHH11TL/TROPICAL LUSH HEX/MSC5X8128 CHP34TL/TROPICAL LUSH PENNY/MSC5X8132 AL28LA/LAGO MIX/MSC910004</p>    <p>CHH11TL CHP34TL AL28LA</p>	<p>H09. HOOK 9 AL8X8LY/LAYLA/MSC910025 SART2X8/TIDAL/MSC910013</p>   <p>AL8X8LY SART2X8</p>	<p>H10. HOOK 10 Q508/BOTANY BAY BLEND COIN/MSC5X8033 Q208/BOTANY BAY BLEND SLICED/MSC5X8025 AL28ME/MENTA MIX/MSC910003</p>    <p>Q508 Q208 AL28ME</p>	
<p>H11. HOOK 11 KAQ3X6/AQUA/MSC5X8056 KMI312/MINT/MSC516083 KSB312/SKY BLUE/MSC516085</p>    <p>KAQ3X6 KMI312 KSB312</p>	<p>H12. HOOK 12 KBL312/BLUE/MSC516074 KBB312/BLUE BELL/MSC516075 TM26AW/ARCTIC WAVE/MSC516097</p>    <p>KBL312 KBB312 TM26AW</p>	<p>H13. HOOK 13 KBT3X6/BLUE TURQUOISE /MSC5X8060 KBM3X6/BLUE MARINE/MC5X8059 CGBM312/BLUE MARINE GROOVE/MSC516065</p>    <p>KBT3X6 KBM3X6 CGBM312</p>	<p>H14. HOOK 14 KEM312/EMERALD/MSC516079 KGB312/BOTTLE GREEN/MSC516076 CGGR312/GREEN GROOVE /MSC516064 KGR312/GREEN/MSC516080</p>     <p>KEM312 KGB312 CGGR312 KGR312</p>
<p>H15. HOOK 15 KCS3X6/CASTILLE/MSC5X8064 KGP3X6/GRAPE/MSC5X8066 KIN312/INDIGO/MSC516081 M3D66UM/ULTRA MARINE/MSC818007</p>     <p>KCS3X6 KGP3X6 KIN312 M3D66UM</p>	<p>H16. HOOK 16 VABC22/BLUE CANAL ARABESQUE/MSC5X8123 MNHBWHI/WHIRL BLEND HERRINGBONE/MSC5X8117 VIBC26/BLUE CANAL INTERLOCK/MSC516100 MN26WHI/WHIRL BLEND INTERLOCK/MSC51694</p>     <p>VABC22 MNHBWHI VIBC26 MN26WHI</p>	<p>H17. HOOK 17 KBY3X6/BLUEBERRY/MSC5X8061 KPI3X6/PINK/MSC5X8078 KPU3X6/PURPLE/MSC5X8080 KLA3X6/LAVENDER/MSC5X8072 M3D66PG/PRISM GLOW/MSC818006</p>      <p>KBY3X6 KPI3X6 KPU3X6 KLA3X6 M3D66PG</p>	

SHOP BY COLOR PLANOGRAM - COOL COLORS - REPLENISHMENT SHEET

HOOK #	PRODUCT SERIES	PRODUCT DESCRIPTION	PRODUCT SKU	SAMPLE CARD SKU	REORDER QTY
H1.	TAKAO	BLUE BEECH - 3X6	TABB3X6	MSC5X8114	
	BOTANY BAY PEBBLES	SEA GREEN - SLICED	Q207	MSC5X8028	
H2.	CHAMELEON	MINT ROSE - HEXAGON 1X1	CHH11MR	MSC5X8136	
	CHAMELEON	MINT ROSE - PENNY ROUND 3/4"	CHP34MR	MSC5X8137	
H3.	KALEIDOSCOPE	URBAN MEADOW - INTERLOCK 2X6	ME26UM	MSC5X8121	
	MODERN EDGE	PISTACHIO - 3X6	KPO3X6	MSC5X8079	
	KALEIDOSCOPE	GREEN BRANCH - 3X6	KGB3X6	MSC5X8067	
H4.	CHAMELEON	SAGE GREEN - HEXAGON 1X1	CHH11SG	MSC5X8131	
	CHAMELEON	SAGE GREEN - PENNY ROUND 3/4"	CHP34SG	MSC5X8135	
	KALEIDOSCOPE	GREEN TURTLE - 3X6	KGT3X6	MSC5X8068	
H5.	P24VAZ	VALLEE AZUR - MINI PROVENZAL 2X4	P24VAZ	MSC5X8141	
	KALEIDOSCOPE	LIGHT BLUE - 3X6	KLB3X6	MSC5X8073	
	KALEIDOSCOPE	COASTAL MIST - 2-1/2X8 NEW!!	KCM2X8 NEW!!	MSC910023 NEW!!	
H6.	TOPIARY	BLUE ATLAS - LEAVES NEW!!	Q618 NEW!!	MSC5X8146 NEW!!	
	KALEIDOSCOPE	SERENE COVE - 2-1/2X8 NEW!!	KSC2X8 NEW!!	MSC910024 NEW!!	
H7.	TOPIARY	OLIVE - LEAVES NEW!!	Q603 NEW!!	MSC5X8145 NEW!!	
	BOTANY BAY PEBBLES	OLIVE - COINS	Q503	MSC5X8033	
	BOTANY BAY PEBBLES	OLIVE - SLICED	Q203	MSC5X8025	
	KALEIDOSCOPE	OLIVE GREEN - 3X6	KOG3X6	MSC5X8076	
	KALEIDOSCOPE	OLIVE GREEN - 2-1/2X8 NEW!!	KOG2X8 NEW!!	MSC910022 NEW!!	
H8.	CHAMELEON	TROPICAL LUSH - HEXAGON 1X1	CHH11TL	MSC5X8128	
	CHAMELEON	TROPICAL LUSH - PENNY ROUND 3/4"	CHP34TL	MSC5X8132	
	ALHAMBRA	LAGO MIX - 2-1/2X8	AL28LA	MSC910004	
H9.	ALHAMBRA	LAYLA - DECO 8X8 NEW!!	AL8X8LY NEW!!	MSC910025 NEW!!	
	HABITAT	TIDAL - 2-1/2X8	SART2X8	MSC910013	
H10.	BOTANY BAY PEBBLES	BOTANY BAY BLEND - COIN	Q508	MSC5X8033	
	BOTANY BAY PEBBLES	BOTANY BAY BLEND - SLICED	Q208	MSC5X8025	
	ALHAMBRA	MENTA MIX - 2-1/2X8	AL28ME	MSC910004	
H11.	KALEIDOSCOPE	AQUA - 3X6	KAQ3X6	MSC5X8056	
	KALEIDOSCOPE	MINT - 3X12	KMI312	MSC516083	
	KALEIDOSCOPE	SKY BLUE - 3X12	KSB312	MSC516085	
H12.	KALEIDOSCOPE	BLUE - 3X12	KBL312	MSC516074	
	KALEIDOSCOPE	BLUE BELL - 3X12	KBB312	MSC516075	
	TUNDRA GLASS	ARCTIC WAVE - INTERLOCK 2X6	TM26AW	MSC516097	
H13.	KALEIDOSCOPE	BLUE TURQUOISE - 3X6	KBT3X6	MSC5X8060	
	KALEIDOSCOPE	BLUE MARINE - 3X6	KBM3X6	MSC5X8059	
	CONTOUR	BLUE MARINE - GROOVE 3X12	CGBM312	MSC516065	
H14.	KALEIDOSCOPE	EMERALD - 3X12	KEM312	MSC516079	
	KALEIDOSCOPE	BOTTLE GREEN - 3X12	KBG312	MSC516076	
	CONTOUR	GREEN GROOVE - 3X12	CGGR312	MSC516064	
	KALEIDOSCOPE	GREEN - 3X12	KGR312	MSC516080	
H15.	KALEIDOSCOPE	CASTILLE - 3X6	KCS3X6	MSC5X8064	
	KALEIDOSCOPE	GRAPE - 3X6	KGP3X6	MSC5X8066	
	KALEIDOSCOPE	INDIGO - 3X12	KIN312	MSC516081	
	COLOR SPLASH	ULTRA MARINE - 6X6	M3D66UM	MSC818007	
H16.	VENETAİN GLASS	BLUE CANAL - ARABESQUE 2X2	VABC22	MSC5X8123	
	GOSFORD GLASS	WHIRL BLEND - HERRINGBONE 1X2	MNHBWHI	MSC5X8117	
	VENETAİN GLASS	BLUE CANAL - INTERLOCK 2X6	VIBC26	MSC516100	
	GOSFORD GLASS	WHIRL BLEND - INTERLOCK 2X6	MNH26WHI	MSC516094	
H17.	KALEIDOSCOPE	BLUEBERRY - 3X6	KBY3X6	MSC5X8061	
	KALEIDOSCOPE	PINK - 3X6	KPI3X6	MSC5X8078	
	KALEIDOSCOPE	PURPLE - 3X6	KPU3X6	MSC5X8080	
	KALEIDOSCOPE	LAVENDER - 3X6	KLA3X6	MSC5X8072	
	COLOR SPLASH	PRISM GLOW - 6X6	M3D66PG	MSC818006	

SHOP BY COLOR PLANOGRAM - HOOK PLACEMENT

17 HOOKS NEEDED FOR NEUTRAL SIDE



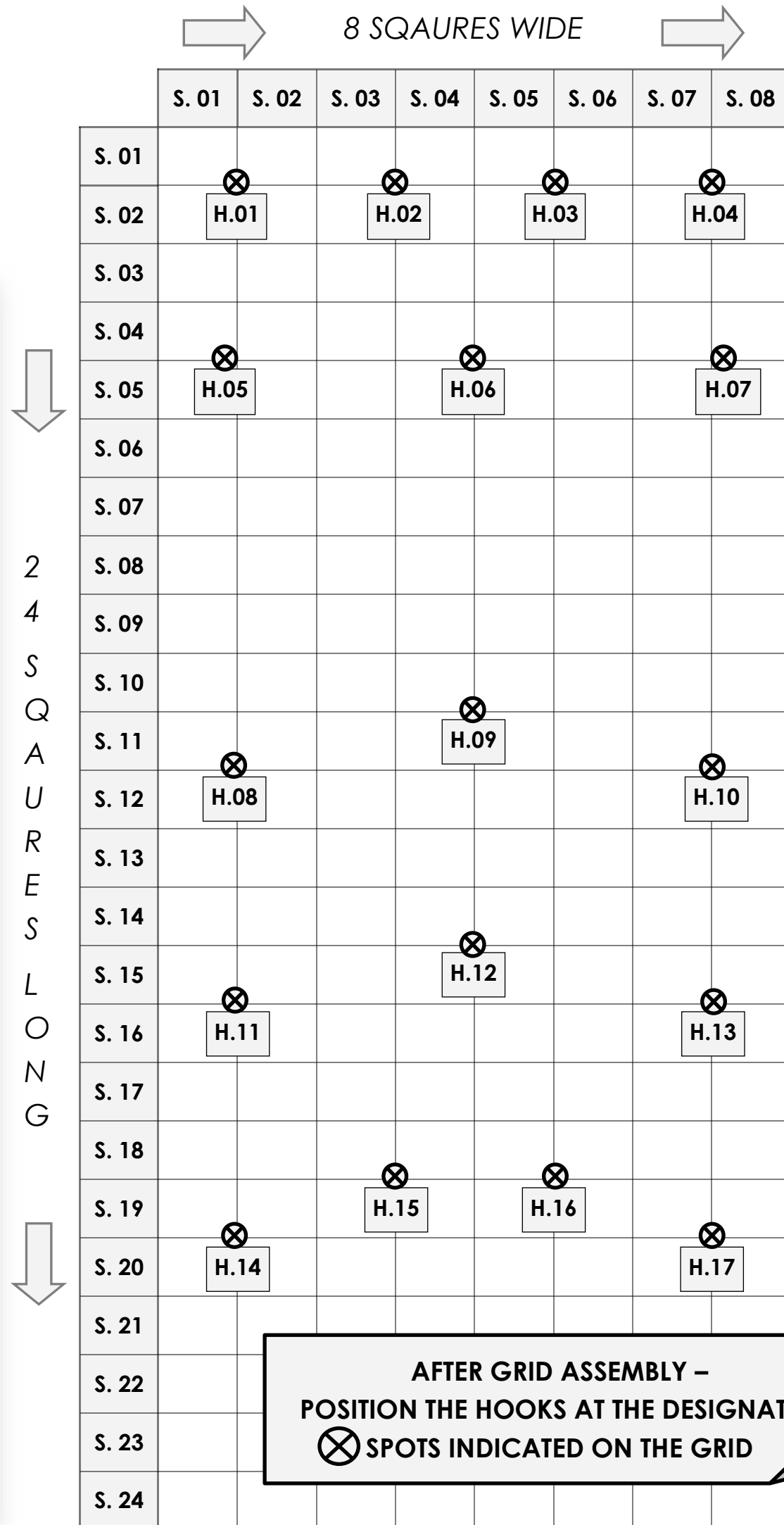





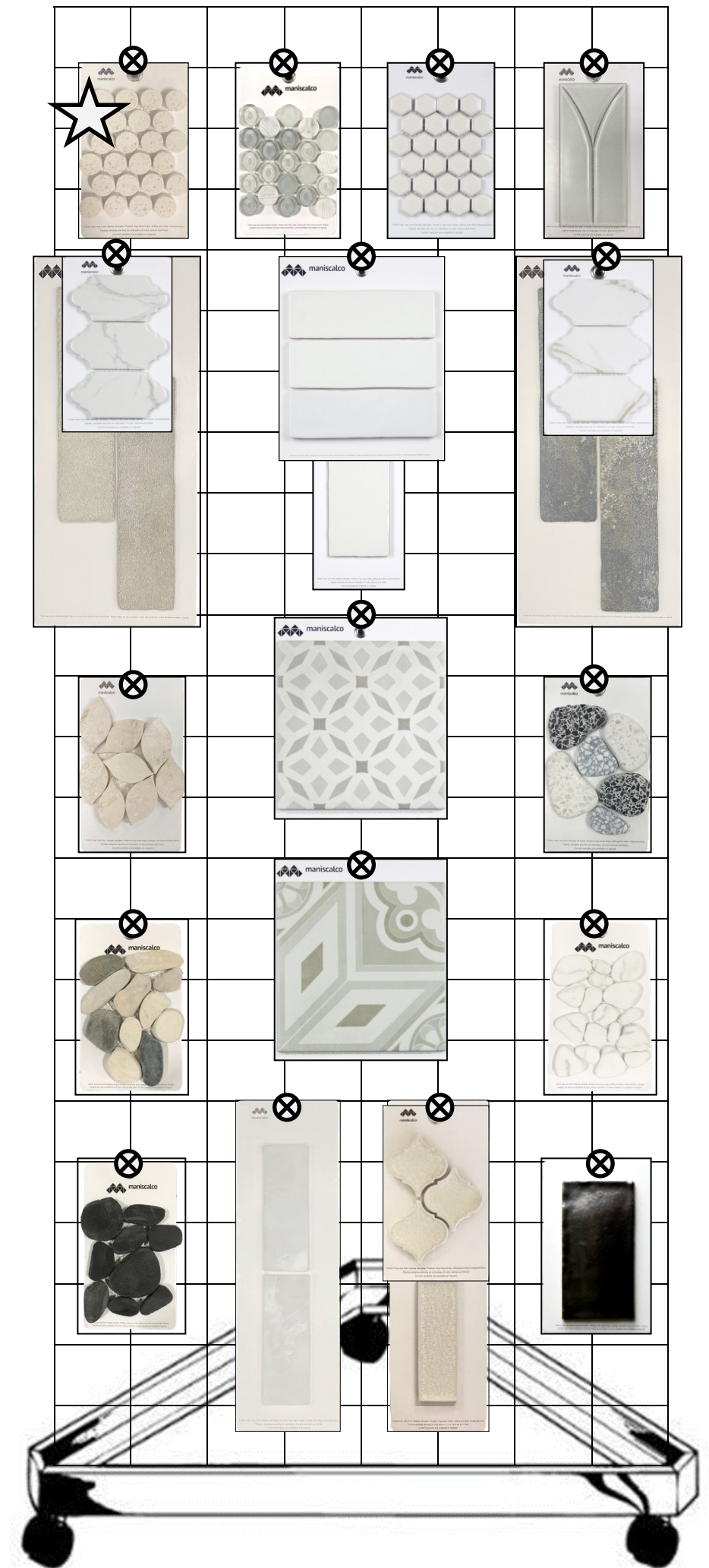







**PRO TIP:
LAYOUT THE HOOKS BEFORE YOU LOAD CARDS**

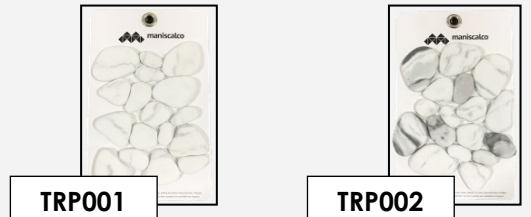

**AFTER GRID ASSEMBLY –
POSITION THE HOOKS AT THE DESIGNATED
⊗ SPOTS INDICATED ON THE GRID**

NEW CARDS!!

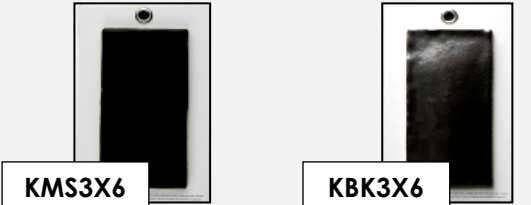

<p>H01. HOOK 1 EPRCC/CRUSHED CRYSTAL PENNY/MSC5X8143 ECOCC/CRUSHED CRYSTAL PEBBLE/MSC5X8110</p>  <p>EPRCC ECOCC</p>	<p>H02. HOOK 2 OLBPDHD04/CARRARA BLEND/MSC5X8048 OLBPDHD05/THALA GREY BLEND/MSC5X8049</p>  <p>OLBPDHD04 OLBPDHD05</p>	<p>H03. HOOK 3 CHH11OP/OPAL HEX/MSC5X8129 CHP34OP/OPAL PENNY/MSC5X8133</p>  <p>CHH11OP CHP34OP</p>	<p>H04. HOOK 4 TAMA3X6/MAGNOLIA/MSC5X8115 ME26WF/WHITE FLASH/MSC5X8122</p>  <p>TAMA3X6 ME26WF</p>
<p>H05. HOOK 5 P24CAR/CARRARA/MSC5X8138 SOBW311/WINDY CITY/MSC818055</p>  <p>P24CAR SOBW311</p>	<p>H06. HOOK 6 AL28CR/CREMA MIX/MSC910010 KSW312/ SOFT WHITE/MSC516086</p>  <p>AL28CR KSW312</p>	<p>H07. HOOK 7 CGWH312/WHITE GROOVE/MSC516060 KWH312/WHITE/MSC516089</p>  <p>CGWH312 KWH312</p> <p>H07. HOOK 7 P24CAL/CALACATTA/MSC5X8139 SOBI311/IRON/MSC818058</p>  <p>P24CAR SOBI311</p>	
<p>H08. HOOK 8 Q613/ASPEN/MSC5X8096 Q617/FOREST BLEND/MSC5X8100 Q615/MESQUITE/MSC5X8098</p>  <p>Q613 Q617 Q615</p>	<p>H09. HOOK 9 PWAR8X8/ARCADE/MSC910016 PWEC8X8/EL CAMINO/MSC910017</p>  <p>PWAR8X8 PWEC8X8</p>	<p>H10. HOOK 10 ECOERB/ECO ROCK BLEND/MSC5X8112 ECOSS/SILVER STUCCO/MSC5X8113 ECOBT/BLACK TOP/ MSC5X8109</p>  <p>ECOERB ECOSS ECOBT</p>	
<p>H11. HOOK 11 Q211/SHADOW BLEND/MSC5X8032 Q206/CREAM/MSC5X8027 Q210/SHADOW/MSC5X8031</p>  <p>Q211 Q206 Q210</p>	<p>H12. HOOK 12 PWPR8X8/PROMENADE/MSC9100018 PWES8X8/EASY STREET/MSC910019</p>  <p>PWPR8X8 PWES8X8</p>	<p>H13. HOOK 13 TRP001/OASIS WHITE/MSC5X8045 TRP002/MIRAGE BLEND/MSC5X8046</p>  <p>TRP001 TRP002</p>	
<p>H14. HOOK 14 Q204/STAINED BLACK/MSC5X8026 Q004/LAVA BLACK/MSC5X8015</p>  <p>Q204 Q004</p>	<p>H15. HOOK 15 TM26SB/SNOW BIRD/MSC516099 TM26IC/ICE CAP/MSC516098 M03304/ASH/MSC516028</p>  <p>TM26SB TM26IC M03304</p>	<p>H16. HOOK 16 VAWV22/WHITE VELVET ARABESQUE/MSC5X8127 VIWV26/WHITE VELVET INTERLOCK/MSC516104</p>  <p>VAWV22 VIWV26</p>	<p>H17. HOOK 17 KMS3X6/METALLIC SILVER/MSC5X8074 KBK3X6/BLACK/MSC5X8058</p>  <p>KMS3X6 KBK3X6</p>

SHOP BY COLOR PLANOGRAM - NEUTRAL COLORS - REPLENISHMENT SHEET

HOOK #	PRODUCT SERIES	PRODUCT DESCRIPTION	PRODUCT SKU	SAMPLE CARD SKU	REORDER QTY
H1.	ECO ROCK	CRUSHED CRYSTAL - PENNY ROUND 7/8"	EPRCC NEW!!	MSC5X8143 NEW!!	
	ECO ROCK	CRUSHED CRYSTAL - PEBBLES	ECOCC	MSC5X8110	
H2.	BENNELONG POINT	CARRARA BLEND - DOTS 7/8"	OLBPDHD04	MSC5X8048	
	BENNELONG POINT	THALA GREY BLEND - DOTS 7/8"	OLBPDHD05	MSC5X8049	
H3.	CHAMELEON	OPAL - HEXAGON 1X1	CHH11OP	MSC5X8129	
	CHAMELEON	OPAL - PENNY ROUND 3/4"	CHP34OP	MSC5X8133	
H4.	TAKAO	MAGNOLIA - 3X6	TAMA3X6	MSC5X8115	
	MODERN EDGE	WHITE FLASH - INTERLOCK 2X6	ME26WF	MSC5X8122	
H5.	PROVENCE	CARRARA - MINI PROVENZAL 2X4	P24CAR	MSC5X8138	
	SOUTH LOOP	WINDY CITY - 3X11	SOBW311	MSC818055	
H6.	ALHAMBRA	CREMA MIX - 2-1/2X8	AL28CR	MSC910010	
	KALEIDOSCOPE	SOFT WHITE - 3X12	KSW312	MSC516086	
	CONTOUR	WHITE - GROOVE 3X12	CGWH312	MSC516060	
	KALEIDOSCOPE	WHITE - 3X12	KWH312	MSC516089	
H7.	PROVENCE	CALACATTA - MINI PROVENZAL 2X4	P24CAL	MSC5X8139	
	SOUTH LOOP	IRON - 3X11	SOBI311	MSC818058	
H8.	TOPIARY	ASPEN - LEAVES	Q613	MSC5X8096	
	TOPIARY	FOREST BLEND - LEAVES	Q617	MSC5X8100	
	TOPIARY	MESQUITE - LEAVES	Q615	MSC5X8098	
H9.	PATHWAYS	ARCADE - 8X8	PWAR8X8	MSC910016	
	PATHWAYS	EL CAMINO - 8X8	PWEL8X8	MSC910017	
H10.	ECO ROCK	ECO ROCK BLEND - PEBBLES	ECOERB	MSC5X8112	
	ECO ROCK	SILVER STUCCO - PEBBLES	ECOSS	MSC5X8113	
	ECO ROCK	BLACK TOP - PEBBLES	ECOBT	MSC5X8109	
H11.	BOTANY BAY PEBBLES	SHADOW BLEND - SLICED	Q211	MSC5X8096	
	BOTANY BAY PEBBLES	CREAM - SLICED	Q206	MSC5X8100	
	BOTANY BAY PEBBLES	SHADOW - SLICED	Q210	MSC5X8098	
H12.	PATHWAYS	PROMENADE - 8X8	PWPR8X8	MSC910018	
	PATHWAYS	EASY STREET - 8X8	PWES8X8	MSC910019	
H13.	LITTLE SANDY PEBBLES	OASIS WHITE - PEBBLES	TRP001	MSC5X8045	
	LITTLE SANDY PEBBLES	MIRAGE BLEND - PEBBLES	TRP002	MSC5X8046	
H14.	BOTANY BAY PEBBLES	STAINED BLACK - SLICED	Q204	MSC5X8026	
	BOTANY BAY PEBBLES	LAVA BLACK - OPUS	Q004	MSC5X8015	
H15.	TUNDRA GLASS	SNOW BIRD - INTERLOCK 2X6	TM26SB	MSC516099	
	TUNDRA GLASS	ICE CAP - INTERLOCK 2X6	TM26IC	MSC516098	
	SUTHERLAND SLATE	ASH - STIX	M03304	MSC516028	
H16.	VENETIAN GLASS	WHITE VELVET - ARABESQUE 2X2	VAWV22	MSC5X8127	
	VENETIAN GLASS	WHITE VELVET - INTERLOCK 2X6	VIWV26	MSC516104	
H17.	KALEIDOSCOPE	METALLIC SILVER - 3X6	KMS3X6	MSC5X8074	
	KALEIDOSCOPE	BLACK - 3X6	KBK3X6	MSC5X8058	

SHOP BY COLOR PLANOGRAM - HOOK PLACEMENT

15 HOOKS NEEDED FOR WARM SIDE

**PRO TIP:
LAYOUT THE HOOKS BEFORE YOU LOAD CARDS**



2
4
S
Q
A
U
R
E
S
L
O
N
G











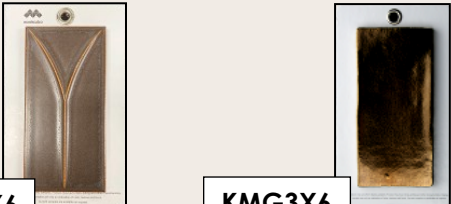

8 SQUARES WIDE

	S. 01	S. 02	S. 03	S. 04	S. 05	S. 06	S. 07	S. 08
S. 01								
S. 02		H.01	H.02		H.03		H.04	
S. 03								
S. 04								
S. 05		H.05		H.06			H.07	
S. 06								
S. 07								
S. 08								
S. 09								
S. 10								
S. 11								
S. 12		H.08	H.09		H.10		H.11	
S. 13								
S. 14								
S. 15								
S. 16								
S. 17								
S. 18								
S. 19		H.12	H.13		H.14		H.15	
S. 20								
S. 21								
S. 22								
S. 23								
S. 24								

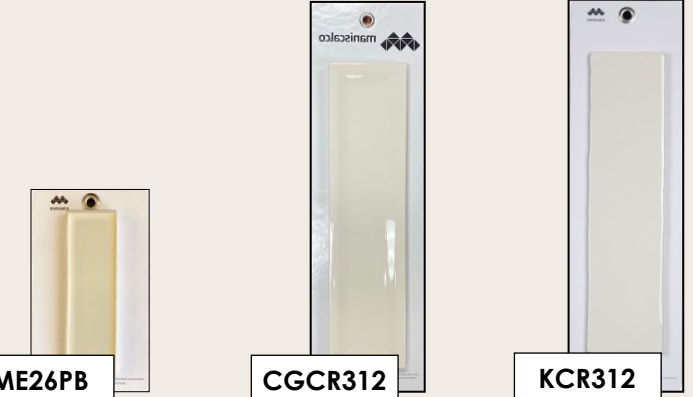
**AFTER GRID ASSEMBLY –
POSITION THE HOOKS AT THE DESIGNATED
⊗ SPOTS INDICATED ON THE GRID**

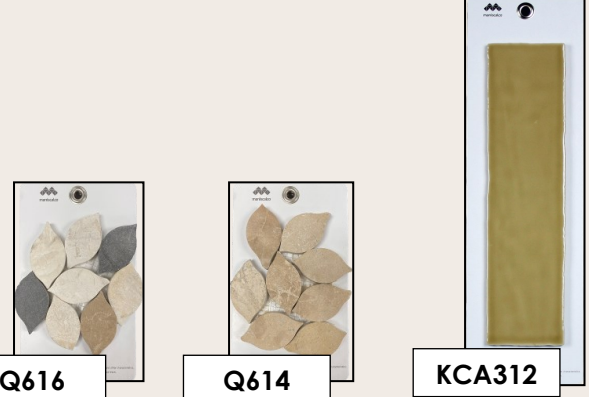
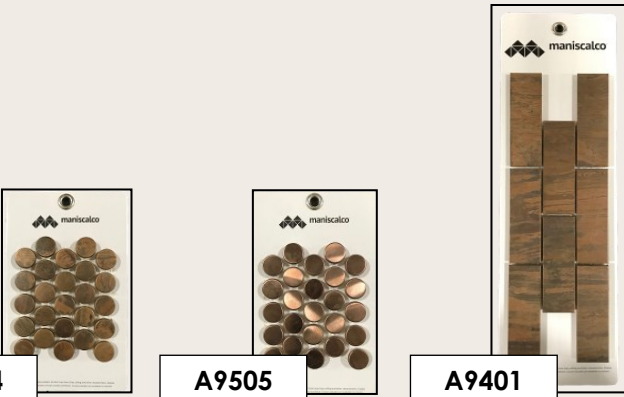
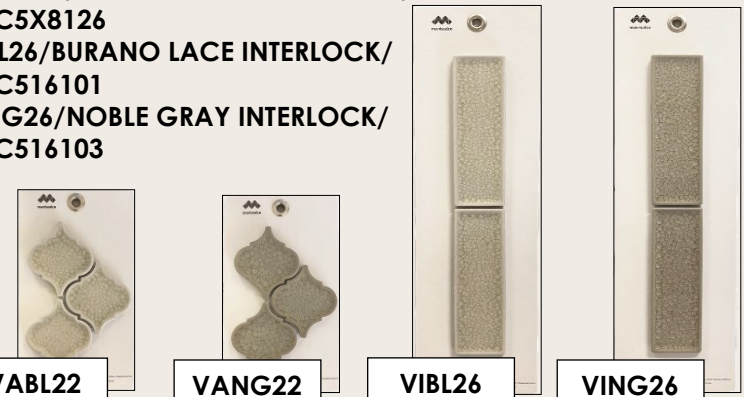
NEW CARDS!!



<p>H01. HOOK 1 TACW3X6/COTTONWOOD/MSC5X8144 Q212/JERVIS BAY BLEND SLICED/MSC5X8095 Q512/ JERVIS BAY BLEND COIN/MSC5X8036</p>  <p>TACW3X6 Q212 Q512</p>	<p>H02. HOOK 2 EPRCS/CEMENT SPRINKLE PENNY/MSC5X8142 ECOCS/CEMENT SPRINKLE PEBBLE/MSC5X8111 KCL3X6/CARAMEL/MSC5X8063 KIV3X6/IVORY/MSC5X8071</p>  <p>EPRCS ECOCS KCL3X6 KIV3X6</p>	<p>H03. HOOK 3 CHH11RS/RUSTIC SUNSET HEX/MSC5X8130 CHP34RS/RUSTIC SUNSET PENNY/MSC5X8134 Q005/OPUS BEIGE/MSC5X8016 Q002/OPUS MIXED/MSC5X8013 Q001/OPUS TAN/MSC5X8014</p>  <p>CHH11RS CHP34RS Q005 Q002 Q001</p>	<p>H04. HOOK 4 TARC3X6/RED CEDAR/MSC5X8116 KMG3X6/METALLIC GOLD/MSC5X8075</p>  <p>TARC3X6 KMG3X6</p>
<p>H05. HOOK 5 AL810YA/YASMINA/MSC9100021 SOBO311/OLD FIRE/MSC818059</p>  <p>AL810YA SOBO311</p>	<p>H06. HOOK 6 P24AMB/AMBRE/MSC5X8140 AL28CA/CAFÉ/MSC910002 SOBC311/CINDER/MSC818056</p>  <p>P24AMB AL28CA SOBC311</p>	<p>H07. HOOK 7 AL8X8TE/TESSINA/MSC9100020 SLFT2X8/PARCHMENT/MSC910012 SOBA311/ANTIQUE CLAY/MSC818057</p>  <p>AL8X8TE SLFT2X8 SOBA311</p>	
<p>H08. HOOK 8 ME26PB/PEARL BLAZE/MSC5X8120 CGCR312/CREAM GROOVE/MSC516061 KCR312/CREAM/MSC516078</p>  <p>ME26PB CGCR312 KCR312</p>	<p>H09. HOOK 9 R403P/CLAY BLEND/MSC5X8041 KLG312/LIGHT GREY/MSC516082 KTA312/TAUPE/MSC516088</p>  <p>R403P KLG312 KTA312</p>	<p>H10. HOOK 10 Q616/WOODLAND BLEND/MSC5X8099 Q614/CHESTNUT/MSC5X8097 KCA312/CAMEL/MSC516077</p>  <p>Q616 Q614 KCA312</p>	<p>H11. HOOK 11 A9504/COPPER ANTIQUE PENNY/MSC5X8003 A9505/COPPER BRUSHED/MSC5X8004 A9401/COPPER ANTIQUE INTERLOCK/MSC516023</p>  <p>A9504 A9505 A9401</p>
<p>H12. HOOK 12 VABL22/BURANLO LACE ARABESQUE/ MSC5X8124 VANG22/NOBLE GRAY ARABESQUE/ MSC5X8126 VIBL26/BURANO LACE INTERLOCK/ MSC516101 VING26/NOBLE GRAY INTERLOCK/ MSC516103</p>  <p>VABL22 VANG22 VIBL26 VING26</p>	<p>H13. HOOK 13 ME26MM/MEGA MIST/MSC5X8119 CGST312/STONE GROOVE/MSC516062 KST312/STONE/MSC516087</p>  <p>ME26MM CGST312 KST312</p>	<p>H14. HOOK 14 VACA22/CAPPUCCINO ARABESQUE/MSC5X8125 TM26AM/ALPINE MEADOW/MSC516096 VICA26/CAPPUCCINO INTERLOCK/MSC516102</p>  <p>VACA22 TM26AM VICA26</p>	<p>H15. HOOK 15 TRP005/SANDY DESERT/MSC5X8047 Q509/KHAKI COIN/MSC5X8035 Q209/KHAKI SLICED/MSC5X8030 KMO312/MOCHA/MSC516084</p>  <p>TRP005 Q509 Q209 KMO312</p>

SHOP BY COLOR PLANOGRAM - WARM COLORS - REPLENISHMENT SHEET

HOOK #	PRODUCT SERIES	PRODUCT DESCRIPTION	PRODUCT SKU	SAMPLE CARD SKU	REORDER QTY
H1.	TAKAO	COTTON WOOD - 3X6 NEW!!	TACW3X6 NEW!!	MSC5X8144 NEW!!	
	BOTANY BAY PEBBLES	JERVIS BAY BLEND - SLICED	Q212	MSC5X8095	
	BOTANY BAY PEBBLES	JERVIS BAY BLEND - COIN	Q512	MSC5X8036	
H2.	ECO ROCK	CEMENT SPRINKLE - PENNY ROUND 7/8"	EPRCS NEW!!	MSC5X8142 NEW!!	
	ECO ROCK	CEMENT SPRINKLE - PEBBLE	ECOCS	MSC5X8111	
	KALEIDOSCOPE	CARAMEL - 3X6	KCL3X6	MSC5X8063	
	KALEIDOSCOPE	IVORY - 3X6	KIV3X6	MSC5X8071	
H3.	CHAMELEON	RUSTIC SUNSET - HEXAGON 1X1	CHH11RS	MSC5X8130	
	CHAMELEON	RUSTIC SUNSET - PENNY ROUND 3/4"	CHP34RS	MSC5X8134	
	BOTANY BAY PEBBLES	BEIGE - OPUS	Q005	MSC5X8016	
	BOTANY BAY PEBBLES	MIXED - OPUS	Q001	MSC5X8013	
	BOTANY BAY PEBBLES	TAN - OPUS	Q002	MSC5X8014	
H4.	TAKAO	RED CEDAR - 3X6	TARC3X6	MSC5X8116	
	KALEIDOSCOPE	METALLIC GOLD - 3X6	KMG3X6	MSC5X8075	
H5.	ALHAMBRA	YASMINA - 8X10	AL810YA	MSC910021	
	SOUTH LOOP	OLD FIRE - 3X11	SOBO311	MSC818059	
H6.	PROVENCE	AMBRE - MINI PROVENZAL 2X4	P24AMB	MSC5X8140	
	ALHAMBRA	CAFÉ MIX - 2-1/2X8	AL28CA	MSC910002	
	SOUTH LOOP	CINDER - 3X11	SOBC311	MSC818056	
H7.	ALHAMBRA	TESSINA - 8X8	AL8X8TE	MSC910020	
	HABITAT	PARCHMENT - 2-1/2X8	SLFT2X8	MSC910012	
	SOUTH LOOP	ANTIQUÉ CLAY - 3X11	SOBA311	MSC818057	
H8.	MODERN EDGE	PEARL BLAZE - INTERLOCK 2X6	ME26PB	MSC5X8120	
	CONTOUR	CREAM - GROOVE 3X12	CGCR312	MSC516061	
	KALEIDOSCOPE	CREAM - 3X12	KCR312	MSC516078	
H9.	DAINTREE EXOTIC	CLAY BLEND - DOTS 7/8"	R403P	MSC5X8041	
	KALEIDOSCOPE	LIGHT GREY - 3X12	KLG312	MSC516082	
	KALEIDOSCOPE	TAUPE - 3X12	KTA312	MSC516088	
H10.	TOPIARY	WOODLAND BLEND - LEAVES	Q616	MSC5X8099	
	TOPIARY	CHESTNUT - LEAVES	Q614	MSC5X8097	
	KALEIDOSCOPE	CAMEL - 3X12	KCA312	MSC516077	
H11.	PERTH PENNY ROUNDS	COPPER ANTIQUE - PENNY ROUND 3/4"	A9504	MSC5X8003	
	PERTH PENNY ROUNDS	COPPER BRUSHED - PENNY ROUND 3/4"	A9505	MSC5X8004	
	MURRAY RIVER METALS	COPPER ANTIQUE - INTERLOCK 1-1/4X4	A9401	MSC516023	
H12.	VENETIAN GLASS	BURANO LACE - ARABESQUE 2X2	VABL22	MSC5X8124	
	VENETIAN GLASS	NOBLE GRAY - ARABESQUE 2X2	VANG22	MSC5X8126	
	VENETIAN GLASS	BURANO LACE - INTERLOCK 2X6	VIBL26	MSC516101	
	VENETIAN GLASS	NOBLE GRAY - INTERLOCK 2X6	VING26	MSC516103	
H13.	MODERN EDGE	MEGA MIST - INTERLOCK 2X6	ME26MM	MSC5X8119	
	CONTOUR	STONE - GROOVE 3X12	CGST312	MSC516062	
	KALEIDOSCOPE	STONE - 3X12	KST312	MSC516087	
H14.	VENETIAN GLASS	CAPPUCCINO - ARABESQUE 2X2	VACA22	MSC5X8125	
	TUNDRA GLASS	ALPINE MEADOW - INTERLOCK 2X6	TM26AM	MSC516096	
	VENETIAN GLASS	CAPPUCCINO - INTERLOCK 2X6	VICA26	MSC516102	
H15.	LITTLE SANDY PEBBLES	SANDY DESERT - PEBBLES	TRP005	MSC5X8047	
	BOTANY BAY PEBBLES	KHAKI - COIN	Q509	MSC5X8035	
	BOTANY BAY PEBBLES	KHAKI - SLICED	Q209	MSC5X8030	
	KALEIDOSCOPE	MOCHA - 3X12	KMO312	MSC516084	

Grid Display Components

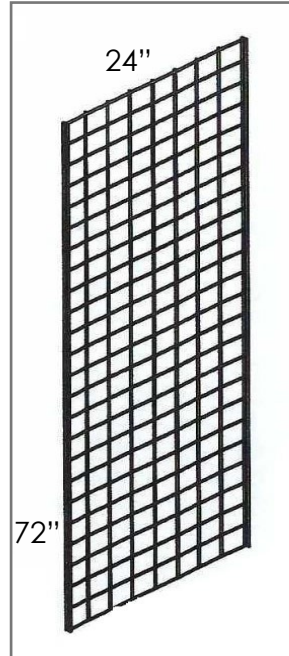
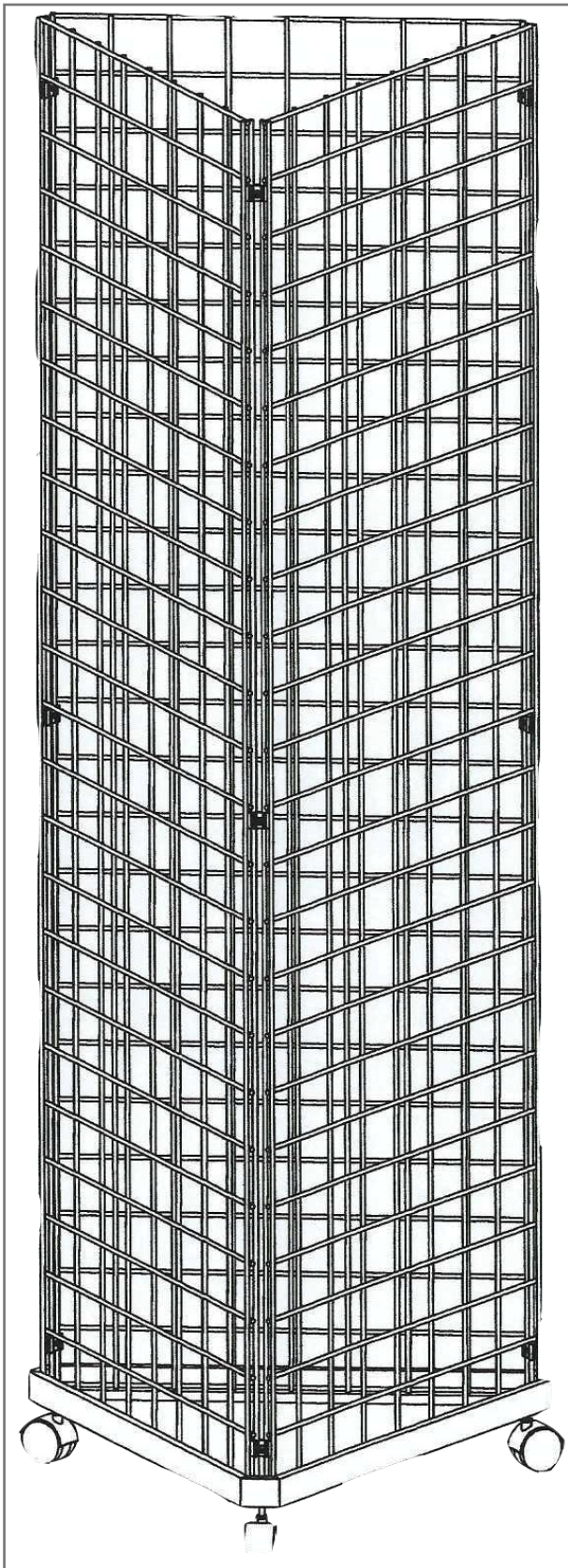

Grid Panel
Qty 3
Dimensions:
24" Wide
72" Tall

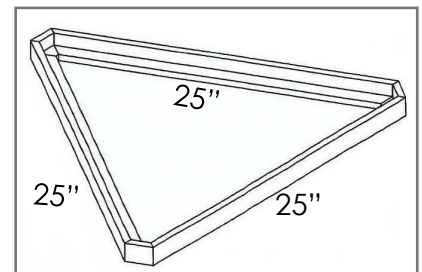

Grid Base
Qty 1
Dimensions:
25" Per Side

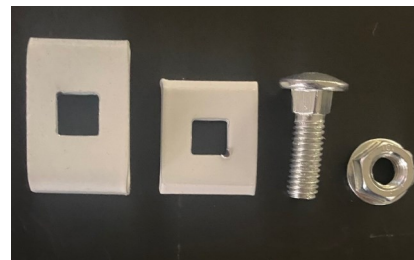

Grid Clips
Qty 9



Castors
Qty 3

Grid Display Assembly

Step 1

Turn the base upside down so that the holes are facing up. Screw the castor (wheel) in the threaded holes. Use large nut to tighten the bolt. Set base aside.

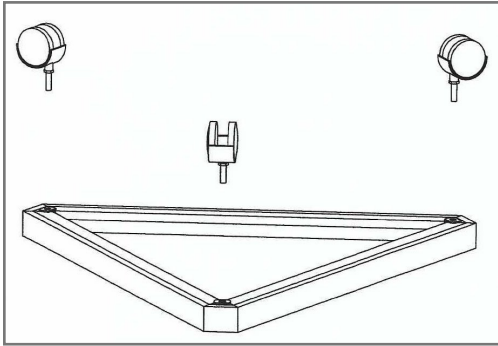

Step 2

Assemble two of the grid panels using the 2 part grid clips, bolt and small nut (Fig.1). Connect the end of one grid panel to the vertical wire of a second grid panel with bolt. Tighten the bolt with the small nut (Fig.2). Grid clips should be located in the second section from the bottom, the middle and the second section of the top of each grid. Once 2 of the panels are connected, connect the third panel.

HORIZONTAL WIRE ON GRID SHOULD BE ON FRONT SIDE
VERTICAL WIRE ON GRID SHOULD BE ON BACK SIDE

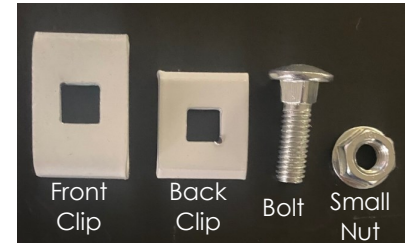

Fig. 1

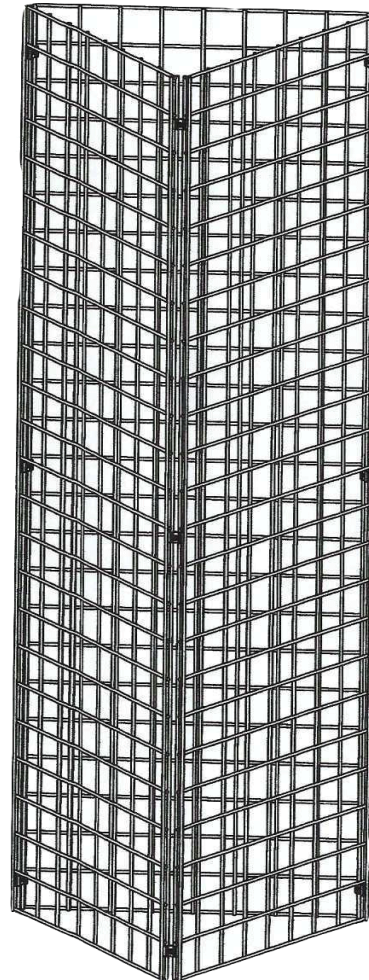

Fig. 2



Step 3

Set the grid panel onto the base.

Step 4

Add hooks and cards using the Planogram.

